

# TS600 Series Programmable Controller User Manual



## Preface

### Overview

Thank you for choosing INVT TS600 series programmable controller (programmable controller for short).

TS600 series programmable controller is new generation of small PLC that INVT independently develops, which supports EtherCAT bus, EtherNet bus, RS485 and high-speed I/O interfaces, and up to 16 local expansion modules. In addition, the programmable controller can be equipped with expansion cards to extend RS232, CANopen, SD card, 4G and other functions.

The manual mainly introduces the installation and wiring of the product, including product information, mechanical installation, and electrical installation.

Read through this manual carefully before installing the programmable controller. For details about the user program development environments and user program design methods, see TS600 Series Programmable Logic Controller Programming and Application Manual and TS600 Series Programmable Logic Controller Command Manual that we issue.

The manual is subject to change without prior notice. Please visit [www.invt.com](http://www.invt.com) to download the latest manual version.

### Readers

Personnel with electrical professional knowledge (such as qualified electrical engineers or personnel with equivalent knowledge).

### To obtain the manual

The manual is not delivered with the product. To obtain the PDF file, you can:

- Visit [www.invt.com](http://www.invt.com), choose Support > Download, and search keywords to download the manual.
- Use your mobile phone to scan the e-manual platform QR code marked on the product housing, and search keywords to download the manual.

### Change history

The manual is subject to change irregularly without prior notice due to product version upgrades or other reasons.

No.	Change description	Version	Release date
1	First release.	V1.0	June 2023

# Contents

<b>Preface</b> .....	<b>i</b>
Overview.....	i
Readers.....	i
To obtain the manual.....	i
Change history.....	i
<b>Contents</b> .....	<b>ii</b>
<b>1 Safety precautions</b> .....	<b>1</b>
1.1 Safety declaration.....	1
1.2 Safety level definition.....	1
1.3 Personnel requirements.....	1
1.4 Safety guidelines.....	1
<b>2 Product overview</b> .....	<b>4</b>
2.1 Product nameplate and model.....	4
2.2 Product specifications.....	5
2.2.1 General specifications.....	5
2.2.2 DI input specifications.....	6
2.2.3 DO output specifications.....	7
2.2.4 RS485 specifications.....	8
2.2.5 EtherCAT specifications.....	9
2.2.6 EtherNet specifications.....	9
2.3 Interface description.....	10
<b>3 Mechanical installation</b> .....	<b>13</b>
3.1 Installation environment requirements.....	13
3.2 Installation and disassembly.....	13
3.2.1 Installation.....	13
3.2.2 Disassembly.....	16
<b>4 Electrical installation</b> .....	<b>19</b>
4.1 Cable specifications.....	19
4.2 DI terminal wiring.....	20
4.3 DO terminal wiring.....	21
4.4 Wiring of power supply terminals.....	22
4.5 RS485 networking wiring.....	22
4.6 EtherCAT networking wiring.....	23
4.7 Ethernet wiring.....	23
<b>5 Other descriptions</b> .....	<b>24</b>
5.1 Programming tool.....	24
5.2 Run and stop operations.....	24

---

5.3 Preventive maintenance .....	24
5.4 SD card user program burning.....	24
5.5 SD card firmware upgrade .....	24
<b>Appendix A Expansion card optional accessories .....</b>	<b>26</b>
<b>Appendix B Dimension drawings .....</b>	<b>27</b>
B.1 Structural dimensions.....	27

# 1 Safety precautions



## 1.1 Safety declaration

Read this manual carefully and follow all the safety precautions before moving, installing, wiring, commissioning and running the programmable controller. Otherwise, equipment damage or physical injury or death may be caused.

We shall not be liable or responsible for any equipment damage or physical injury or death caused due to failure to follow the safety precautions.

## 1.2 Safety level definition

To ensure personal safety and avoid property damage, you must pay attention to the warning symbols and tips in the manual.

Warning symbols	Name	Description
	Danger	Severe personal injury or even death can result if related requirements are not followed.
	Warning	Personal injury or equipment damage can result if related requirements are not followed.

## 1.3 Personnel requirements

**Trained and qualified professionals:** People operating the equipment must have received professional electrical and safety training, and must be familiar with all steps and requirements of equipment installing, commissioning, running and maintaining and capable to prevent any emergencies according to experiences.

## 1.4 Safety guidelines

General principles	
	<ul style="list-style-type: none"> <li>Only trained and qualified professionals are allowed to carry out related operations.</li> <li>Do not perform wiring, inspection or component replacement when power supply is applied.</li> </ul>

Delivery and installation	
	<ul style="list-style-type: none"> <li>Do not install the programmable controller on inflammables. In addition, prevent the programmable controller from contacting or adhering to inflammables.</li> <li>Install the programmable controller in a lockable control cabinet of at least IP20, which prevents the personnel without electrical</li> </ul>

**Delivery and installation**

equipment related knowledge from touching by mistake, since the mistake may result in equipment damage or electric shock. Only personnel who have received related electrical knowledge and equipment operation training can operate the control cabinet.

- Do not run the programmable controller if it is damaged or incomplete.
- Do not contact the programmable controller with damp objects or body parts. Otherwise, electric shock may result.

**Wiring**

- Fully understand the interface types, specifications, and related requirements before wiring. Otherwise, incorrect wiring cause abnormal running.
- Before power-on for running, ensure that each module terminal cover is properly installed in place after the installation and wiring are completed. This prevents a live terminal from being touched. Otherwise, physical injury, equipment fault or misoperation may result.
- Install proper protection components or devices when using external power supplies for the programmable controller. This prevents the programmable controller from being damaged due to external power supply faults, overvoltage, overcurrent, or other exceptions.

**Commissioning and running**

- Before power-on for running, ensure that the working environment of the programmable controller meets the requirements, the input power specifications meet the requirements, the wiring is correct, and a protection circuit has been designed to protect the programmable controller so that the programmable controller can run safely even if an external device fault occurs.
- For modules or terminals requiring external power supply, configure external safety devices such as fuses or circuit breakers to prevent damage caused due to external power supply or device faults.

**Maintenance and component replacement**

- During maintenance and component replacement, take measures to prevent screws, cables and other conductive matters from falling into the internal of the programmable controller.

**Disposal**

- This programmable controller contains heavy metals. Dispose of a scrap programmable controller as industrial waste.



- Dispose of a scrap programmable controller separately at an appropriate collection point but not place it in the normal waste stream.

## 2 Product overview

### 2.1 Product nameplate and model

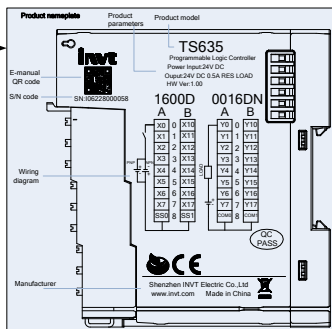
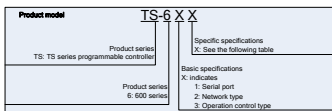

Model	Specifications
TS611	16 inputs and 16 transistor outputs, 1×USB (Type-C), 2×RS485, 8 200K inputs, and 8 200K outputs
TS621	16 inputs and 16 transistor outputs, 1×USB (Type-C), 2×RS485, 8 200K inputs, 8 200K outputs, and 2×EtherNet
TS633	16 inputs and 16 transistor outputs, 1×USB (Type-C), 2×RS485, 8 200K inputs, 8 200K outputs, 2×EtherNet, 1×EtherCAT, and 8 axes (EtherCAT bus) in maximum
TS634	16 inputs and 16 transistor outputs, 1×USB (Type-C), 2×RS485, 8 200K inputs, 8 200K outputs, 2×EtherNet, 1×EtherCAT, and 16 axes (EtherCAT bus) in maximum
TS635	16 inputs and 16 transistor outputs, 1×USB (Type-C), 2×RS485, 8 200K inputs, 8 200K outputs, 2×EtherNet, 1×EtherCAT, and 32 axes (EtherCAT bus) in maximum



## 2.2 Product specifications

### 2.2.1 General specifications

Item	TS635	TS634	TS633	TS621	TS611
EtherNet interface	2 channels	2 channels	2 channels	2 channels	-
EtherCAT interface	1 channel	1 channel	1 channel	-	-
Max. number of axes (bus+pulse)	32 axes	16 axes	8 axes	-	-
RS485 bus	2 channels, supporting Modbus RTU master/slave function				
EtherNet bus	Support ModbusTCP/UDP, program upload and download, and firmware upgrade				
USB interface	1 channel, Type-C interface, supporting program upload and download, and firmware upgrade				
DI input	16 inputs, including 8 high-speed inputs of 200kHz				
DO output	16 outputs, including 8 high-speed outputs of 200kHz				
Pulse axis	Support up to 4 pulse axes				
Input power	24V DC (-15% – +20%)/1A, supporting reversal protection				
Power dissipation of a single unit	<3W				
Backplane bus power supply	5V/2.5A				
Power-failure protection function	Supported (retention by the internal flash)  <b>Note:</b> (no protection within 30 seconds after power-on)				
Real-time clock	Supported (CR2032 battery is optional, and the duration of the real-time clock without batteries is about four days)				
Local expansion modules	Up to 16, disallowing hot swapping.				
Local expansion card	One expansion card, supporting SD card, CANopen card, RS232 card, 4G IoT card and so on				
Program language	LD, SFC, IL				
Program download	USB port, Ethernet interface, SD card (expansion card), and remote download (expansion card)				
Program data capacity	200K step user program 2MByte user-defined variables, in which 128kByte support the power-failure protection function. Approx. 150K soft components, in which the soft component data numbered 1000 or higher support the power-failure				

Item	TS635	TS634	TS633	TS621	TS611
	protection function.				
Product weight	About 0.4kg				
Product dimensions	For details, see Appendix A Expansion card optional accessories.				

 **Note:**

- “-” indicates that it is not supported.
- This product supports the power supply of PC USB interface dedicated to the PLC (without connecting to the expansion module), and the supply current of the PC USB interface shall be not less than 1A.
- If the service power of the PC USB interface is insufficient, resulting in the fact that the PLC cannot be booted up or burn the program normally, you shall disconnect the USB interface first, change to use 24VDC power supply for the PLC, and then connect to the USB interface.

### 2.2.2 DI input specifications

Item	Description
Input type	Digital input
Number of input channels	16 channels
Input mode	Source and sink type
Input voltage class	24V DC (-10%~+10%)
Input current	X0–X7 channels: Input current is 13.5mA (typical value) when the channel is ON; input current is less than 1.7mA when the channel is OFF. X10–X17 channels: Input current is 4.7mA (typical value) when the channel is ON; input current is less than 0.9mA when the channel is OFF.
Max. input frequency	X0–X7 channels: 200kHz; X10–X17 channels: 200kHz
Input resistance	Typical value of X0–X7 channels: 1.7k $\Omega$ ; Typical value of X10–X17 channels: 5.1k $\Omega$ .
ON voltage	$\geq 15\text{VDC}$
OFF voltage	$\leq 5\text{VDC}$
Isolation method	Capacitive isolation
Common terminal method	8CH/group

Item	Description
Input action display	When the input is in the driving state, the input indicator is on (software control).

### 2.2.3 DO output specifications

Item	Description
Output type	Transistor output
Number of output channels	16 channels
Output mode	Sink
Output voltage class	24V DC (-10%~+10%)
Output load (resistance)	0.5A/point, 2A/group
output load (inductance)	7.2W/point, 24W/group
Hardware response time	$\leq 2\mu\text{s}$
Load current requirement	If the output frequency is greater than 10kHz, the load current is greater than or equal to 12mA.
Max. output frequency	Resistive load of 200kHz, inductive load of 0.5Hz, lamp load of 10Hz
Leakage current at OFF	Below $30\mu\text{A}$ (24V typical voltage)
Max. residual voltage at ON	$\leq 0.5\text{VDC}$
Isolation method	Capacitive isolation
Common terminal method	8CH/group
Short-circuit protection function	Supported
External inductive load requirement	When connecting to an external inductive load, it is required to connect a flyback diode. The wiring diagram is shown in Figure 2-1.
Output action display	When the output is valid, the output indicator is on (software control).
Output current rating	When the product works at the temperature of $55^{\circ}\text{C}$ , the current at the common terminal of each group cannot exceed 1A. For the derating curve, refers to Figure 2-2.

Figure 2-1 Diagram for connecting inductive load to flyback diode

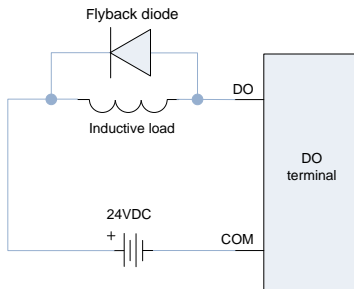
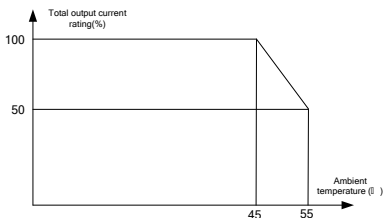

Figure 2-2 Output current rating curve



## 2.2.4 RS485 specifications

Item	Description
Supported channels	2 channels
Hardware interface	Pluggable terminal (sharing the 2x4PIN terminal with the power supply)
Isolation method	No isolation
Terminal resistor	Built-in terminal resistor, you can choose whether to connect it through the DIP switch on the side.
Number of slave nodes	Each channel supports up to 31 slaves.
Communication baud rate	9600/19200/38400/57600/115200 bps
Input protection	Support 24V mis-insertion protection

### 2.2.5 EtherCAT specifications

Item	Description
Communication protocol	EtherCAT
Supported service	CoE (PDO/SDO)
Synchronization method	Distributed clocks for the servo; Input and output synchronization for IO
Physical layer	100BASE-TX
Baud rate	100Mbps (100Base-TX)
Duplex mode	Full duplex
Topology structure	Linear topology structure
Transmission medium	Category-5 or higher network cables
Transmission distance	Less than 100m between two nodes
Number of slaves	Up to 72 slaves
EtherCAT frame length	44 bytes–1498 bytes
Process data	Up to 1486 bytes contained in a single Ethernet frame

### 2.2.6 EtherNet specifications

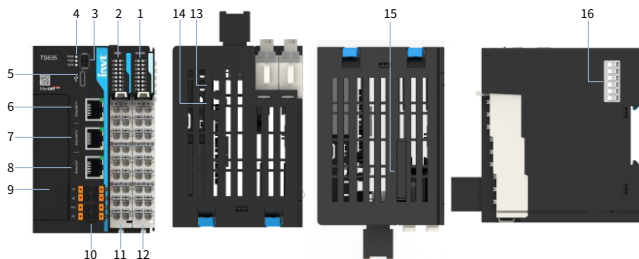

Item	Description
Communication protocol	Standard Ethernet protocol
Physical layer	100BASE-TX
Baud rate	100Mbps (100Base-TX)
Duplex mode	Full duplex
Topology structure	Linear topology structure
Transmission medium	Category-5 or higher network cables
Transmission distance	Less than 100m between two nodes

## 2.3 Interface description

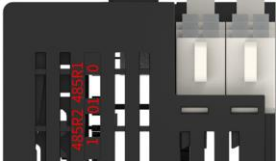

No.	Port type	Interface sign	Definition	Description
1	I/O indicator	0016DN	IO state display	On: The output is valid. Off: No output.
2	I/O indicator	1600D	IO state display	On: The input is valid. Off: The input is invalid.
3	Start/stop DIP switch	RUN	User program running state	Turn to RUN: The user program runs. Turn to STOP: The user program stops.
		STOP		
4	Running state indicator	PWR	Power state display	On: The power supply is normal. Off: The power supply is abnormal.
		RUN	Running state display	Blink: The user program is running. On/off: The user program stops.
		ERR	Running error state display	On: A error occurs. Off: No error occurs.
5	Type-C interface		Communication between USB and PC	Used for program download and debugging.
6	Ethernet interface	EtherNet1	Ethernet communication interface	Default IP: 192.168.1.10

No.	Port type	Interface sign	Definition	Description
7	Ethernet interface	EtherNet2	Ethernet communication interface	Default IP: 192.168.2.10
8	EtherCAT interface	EtherCAT	EtherCAT communication interface	-
9	Expansion card slot	-	Expansion card slot, used for function extension.	For optional accessories of the expansion cards, see Appendix A Expansion card optional accessories.
10	Power supply terminals	A1	Channel 1 485 communication signal+	-
		B1	Channel 1 485 communication signal-	-
		A2	Channel 2 485 communication signal+	-
		B2	Channel 2 485 communication signal-	-
		GND	485 communication signal reference ground	-
		24V	DC 24V power supply +	-
		0V	DC 24V power supply -	-
		PE	Protection ground	-
11	DI input	-	16 inputs	For details, see section 4.2 DI terminal wiring.
12	DO output	-	16 outputs	For details, see section 4.3 DO terminal wiring.
13	Terminal resistor DIP switch 1	485R1	RS485 bus 1 is equipped with a built-in 120Ω	Turn to 0: The built-in terminal resistor is disconnected.

No.	Port type	Interface sign	Definition	Description
			terminal resistor DIP switch.	Turn to 1: The built-in terminal resistor is connected.
14	Terminal resistor DIP switch 2	485R2	RS485 bus 2 is equipped with a built-in 120Ω terminal resistor DIP switch.	Turn to 0: The built-in terminal resistor is disconnected. Turn to 1: The built-in terminal resistor is connected.
				
15	Button battery container	CR2032	RTC clock button battery container	Applicable to CR2032 button battery. <b>Note:</b> The product is not equipped with the button battery as standard configuration by default.
				
16	Backplane connector	-	Local expansion backplane bus	Connected to the local expansion modules.



## 3 Mechanical installation

### 3.1 Installation environment requirements

The operability, maintainability, and environment resistance shall be fully considered when the product is installed on the DIN rail.

Item	Specifications
IP rating	IP20
Pollution level	Level 2: Generally, there is only non-conductive pollution, but the occasional situation that transient conductivity caused by condensation must be taken into account.
Altitude	2000m (80kPa)
Overcurrent protection device	1.1A fuse
Max. working temperature	45°C in full load Derating is required if the ambient temperature reaches 55°C. For details, see Figure 2-2.
Storage temperature and humidity range	Temperature: 20°C–60°C; relative humidity: less than 90% and no condensation
Transportation temperature and humidity range	Temperature: 40°C–70°C; relative humidity: less than 95% and no condensation
Working temperature and humidity range	Temperature: 20°C–55°C; relative humidity: less than 95% and no condensation

### 3.2 Installation and disassembly

#### 3.2.1 Installation

##### 3.2.1.1 Master installation

The installation steps are as follows:

Align the master to the DIN rail, and press it inwards until the master and the DIN rail are clamped (there is an obvious sound of clamping after they are installed in place).

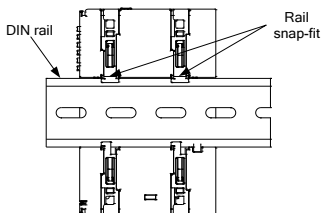
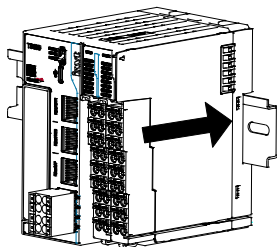

**Note:** The master uses DIN rail for installation.

### 3.2.1.2 Installation between the master and the module

The installation steps are as follows:

Align the module with the connecting rail to the master slide rail and push inward until the module and the DIN rail are clamped (there is an obvious sound of clamping after they are installed in place).

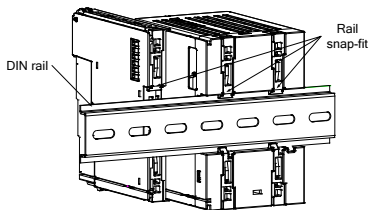
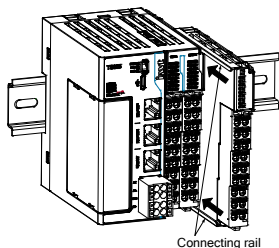

**Note:** The master and the module use DIN rail for installation.

### 3.2.1.3 Expansion card installation

Take out the cover before installing the expansion card. The installation steps are as follows.

Step 1 Use a tool to gently pry the cover snap-fits on the side of the product (in sequence of position 1 and 2), and take out the cover horizontally to the left.

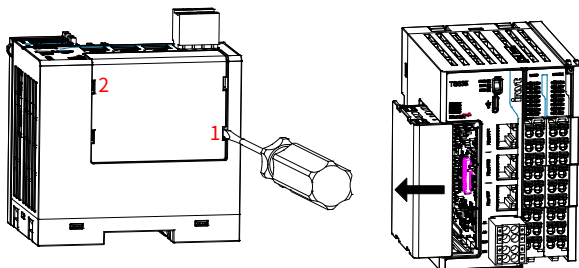

Step 2 Slide the expansion card into the guide slot in parallel, then press the clip positions on the upper and lower sides of the expansion card until the expansion card is clamped (there is an obvious sound of clamping after they are installed in place).

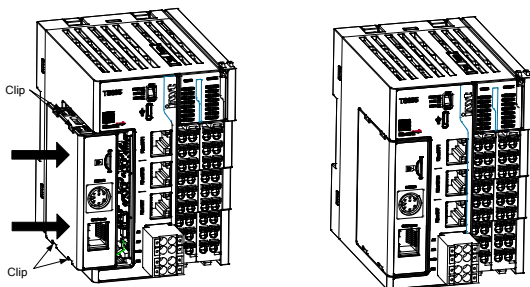

#### 3.2.1.4 Button battery installation

Step 1 Open the button battery cover.

Step 2 Push the button battery into the button battery slot in the correct direction, and close the button battery cover.

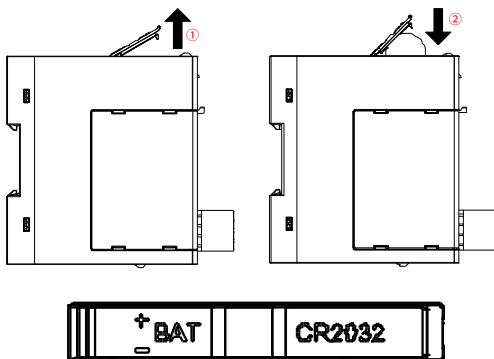
**Note:**

- Please note the anode and cathode of the battery.
- When a battery is installed and the programming software reports an alarm of low battery, the battery needs to be replaced.

### 3.2.2 Disassembly

#### 3.2.2.1 Master disassembly

The disassembly steps are as follows:

Step 1 Use a screwdriver or similar tools to pry up the rail snap-fit.

Step 2 Pull the module straight ahead at the snap-fit position (raised part).

Step 3 Press the top of the rail snap-fit into place.

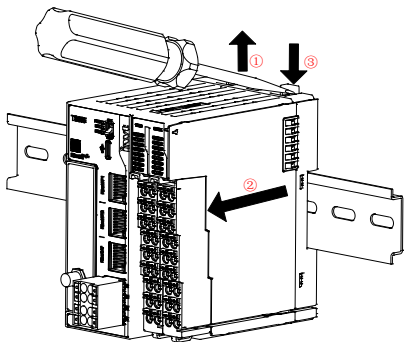

### 3.2.2.2 DI and DO terminal disassembly

The disassembly steps are as follows:

Step 1 Press down the clip on the top of the terminal (raised part).

Step 2 Press and pull out the terminal simultaneously.

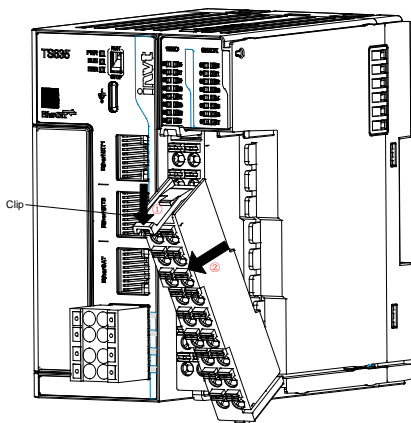

### 3.2.2.3 Button battery disassembly

The disassembly steps are as follows:

Step 1 Open the button battery cover. (For details, see section 3.2.1.4 Button battery installation)

Step 2 Disassemble the DI terminal. (For details, see section 3.2.2.2 DI and DO terminal disassembly)

Step 3 Use a small screwdriver to gently push out the button battery, as shown in the following figure.

Step 4 Take out the battery and close the button battery cover.

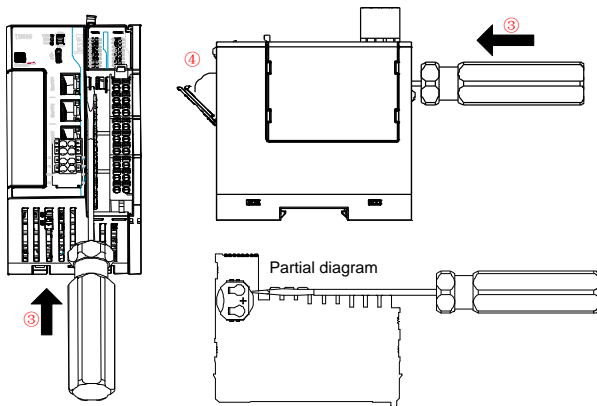

## 4 Electrical installation

### 4.1 Cable specifications

Table 4-1 Single cable dimensions

Applicable wire diameter		Tube-type crimp
Chinese standard/mm <sup>2</sup>	American standard/AWG	
0.3	22	
0.5	20	
0.75	18	
1.0	18	
1.5	16	

Figure 4-1 Ethernet cable diagram



Pin	Signal	Signal direction	Signal description
1	TD+	Output	Data transmission +
2	TD-	Output	Data transmission-
3	RD+	Input	Data receiving +
4	-	-	Unused
5	-	-	Unused
6	RD-	Input	Data receiving-
7	-	-	Unused
8	-	-	Unused

## 4.2 DI terminal wiring

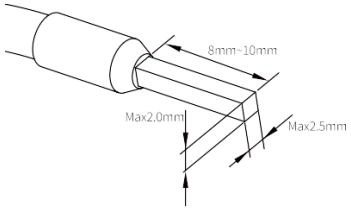
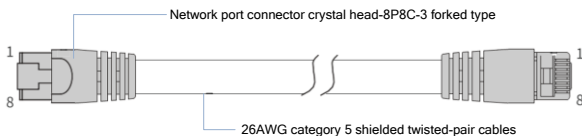
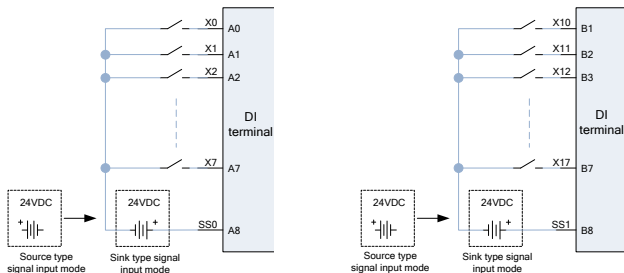

Sign	Signal description	Sign	Signal description
A0	DI0 channel input	B0	DI10 channel input
A1	DI1 channel input	B1	DI11 channel input
A2	DI2 channel input	B2	DI12 channel input
A3	DI3 channel input	B3	DI13 channel input
A4	DI4 channel input	B4	DI14 channel input
A5	DI5 channel input	B5	DI15 channel input
A6	DI6 channel input	B6	DI16 channel input
A7	DI7 channel input	B7	DI17 channel input
A8	DI0–DI7 channel common terminal	B8	DI10–DI17 channel common terminal

### Note:

- The total length of high-speed IO interface connection cable shall be within 3 meters.
- During cable routing, separate the connection cables from other cables that transmit strong interference signals, such as power cables (high voltage and large current), but not bind the connection cables with the latter together. In addition, avoid parallel routing.



### 4.3 DO terminal wiring

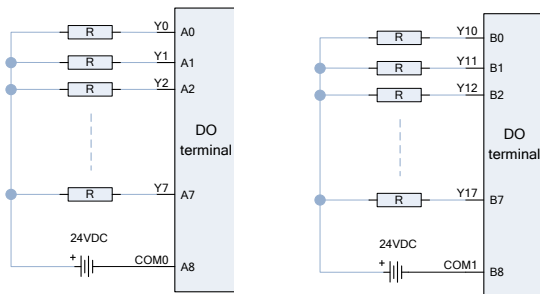

Sign	Signal description	Sign	Signal description
A0	DO0 channel output	B0	DO10 channel output
A1	DO1 channel output	B1	DO11 channel output
A2	DO2 channel output	B2	DO12 channel output
A3	DO3 channel output	B3	DO13 channel output
A4	DO4 channel output	B4	DO14 channel output
A5	DO5 channel output	B5	DO15 channel output
A6	DO6 channel output	B6	DO16 channel output
A7	DO7 channel output	B7	DO17 channel output
A8	DO0–DO7 channel common terminal	B8	DO10–DO17 channel common terminal

**Note:** When connecting to an external inductive load, it is required to connect a flyback diode. The wiring diagram is shown as follows.

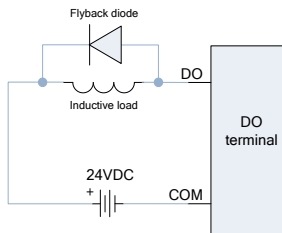

## 4.4 Wiring of power supply terminals

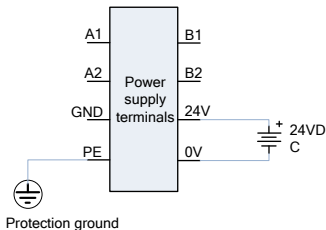

## 4.5 RS485 networking wiring

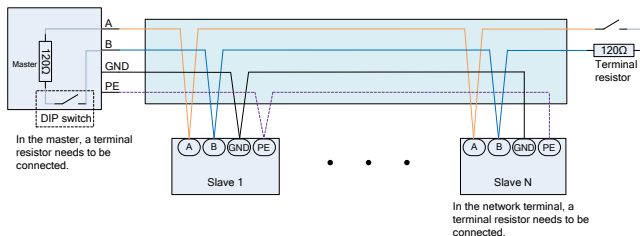

### Note:

- It is recommended that the shielded twisted pair be used as the RS485 bus. 485A and 485B use twisted pair connection.
- Each end of the bus connects a 120Ω terminal resistor to prevent signal reflection.
- For all nodes, the reference grounds of the 485 signal are connected together.
- The distance from the bus to each node must be less than 3 meters.

## 4.6 EtherCAT networking wiring

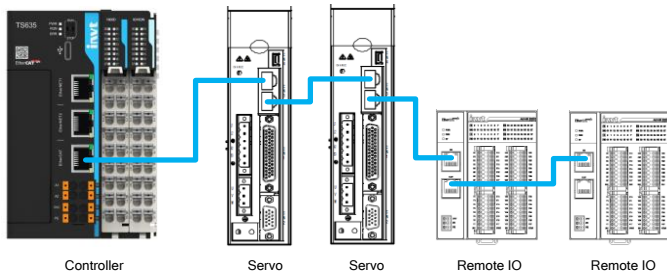

### Note:

- It is required to use shielded twisted-pair cables of category 5, plastic injection moulded and iron shelled, compliant with EIA/TIA568A, EN50173, ISO/IEC11801, EIA/TIA bulletin TSB, and EIA/TIA SB40-A&TSB36.
- The network cable must pass the conductivity test 100%, without short circuit, opened circuit, dislocation or poor contact.
- When connecting the network cable, hold the crystal head of the cable and insert it into the Ethernet interface (RJ45 interface) until it makes a click sound.
- When removing the installed network cable, press the tail mechanism of the crystal head and pull out it from the product horizontally.

## 4.7 Ethernet wiring

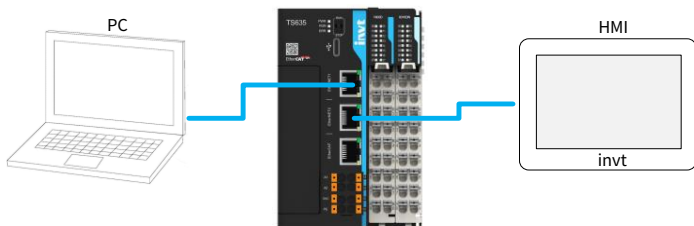

## 5 Other descriptions

### 5.1 Programming tool

Programming tool: AutostationPro.

To obtain the programming tool: Visit [www.invt.com](http://www.invt.com), choose Support > Download, and search keywords to download the programming tool.

### 5.2 Run and stop operations

After programs are written to the PLC, perform startup and shutdown as follows.

- When running the system, set the system to RUN state and ensure that the RUN indicator flashes (yellow-green).
- When stopping the system, set the system to STOP state (the system also can be stopped by the upper computer background).

### 5.3 Preventive maintenance

- Clean the programmable controller regularly, and prevent foreign matters falling into the controller.
- Ensure good ventilation and heat dissipation conditions for the controller.
- Formulate maintenance instructions and regularly test the controller.
- Regularly check the wiring and terminals to ensure that they are securely fastened.

### 5.4 SD card user program burning

Step 1 The burning file is compiled and generated by the programming tool and stored in the root directory of the Micro SD card.

Step 2 Install the Micro SD card in the expansion card slot first, and then on the product.

Step 3 Power on the product, the RUN indicator flashes quickly (4Hz frequency) during the burning process, and the RUN indicator flashes slowly (1Hz frequency) after the burning is successful.

Step 4 Re-power the product.

 **Note:** Power off the product before installing the TF expansion card.

### 5.5 SD card firmware upgrade

Step 1 Store the upgrade file in the root directory of the Micro SD card.

Step 2 Install the Micro SD card in the expansion card slot first, and then on the product.



Step 3 Power on the product, the RUN indicator flash quickly (4Hz frequency) for 3s

and then stay on, it indicates that the firmware is being upgraded. When the RUN indicator returns to flash slowly (1Hz frequency), it indicates that the firmware upgrade is completed.

Step 4 Remove the Micro SD card and re-power the product.

 **Note:** Power off the product before installing the TF expansion card.

## Appendix A Expansion card optional accessories

No.	Model	Specifications
1	TS-CAN-232	Support Micro SD card, CANopen bus, and one RS232 
2	TS-4G	Support Micro SD card and 4G IoT 

## Appendix B Dimension drawings

### B.1 Structural dimensions

Figure B-1 Product dimension diagram (unit: mm)

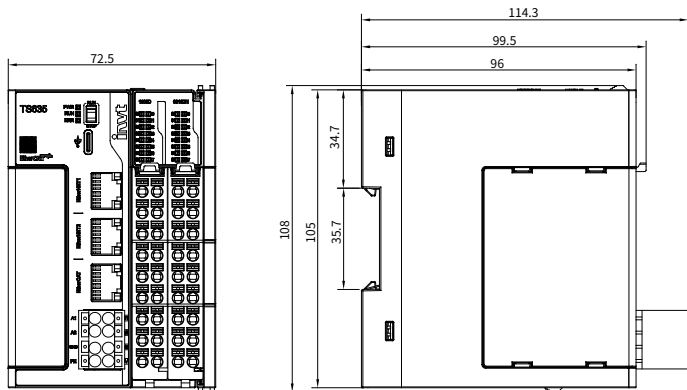

*Your Trusted Industry Automation Solution Provider*



**Shenzhen INVT Electric Co., Ltd.**

Address: INVT Guangming Technology Building, Songbai Road, Matian,  
Guangming District, Shenzhen, China

**INVT Power Electronics (Suzhou) Co., Ltd.**

Address: No. 1 Kunlun Mountain Road, Science & Technology Town,  
Gaixin District, Suzhou, Jiangsu, China

**Website:** [www.invt.com](http://www.invt.com)



INVT mobile website



INVT e-manual



6 6 0 0 1 - 0 1 1 6 7